

AVI150 SYSTEM

Aviglass Collections

Doors & Window Systems



TYPE OF GLAZING



SYSTEM ENHANCE

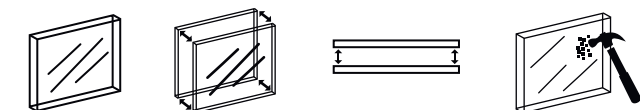

SLIDING SYSTEM







INFORMATION CONTENT



- 1.** Cover
- 2.** Index
- 3.** AviGlass Nomenclature
- 4.** Window system
- 5.** General description and recommendations for use
- 6.** Glazing Type
- 7.** System Type
- 8.** Type of operator and opening
- 9.** Technical drawing
- 10.** Projects
- 13.** Client reviews
- 14.** Contact information

AVIGLASS NOMENCLATURE

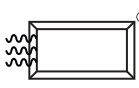
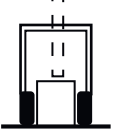

DOORS & WINDOW SYSTEMS

	Doors and windows	Design system that adapts to wall and floor to ceiling installations.
	Facades and large heights	Enveloping system, with high wind resistance, with panoramic views that allow the entrance of natural light.
	Sliding	Sliding opening systems with solutions adaptable to the specific needs of each project.
	Panoramic views	System focused on creating open and airy environments. Less aluminum, more glass.
	Against hurricanes	Guaranteed system for environmental protection and extreme climates.
	Profiles of high strength	Supports heavy loads.

TYPES OF GLAZING

	Monolithic	Glass sheet consisting of a single sheet, with a variety of thicknesses.
	Laminated	It is a type of safety glass that is composed of two or more layers of glass joined together by an intermediate layer of plastic material.
	Insulated	Monolithic or laminated crystals separated by an air or gas chamber, which generate customized thermal effects.

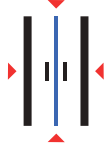
SYSTEMS ENHANCE

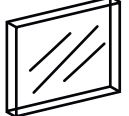
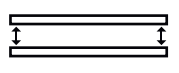
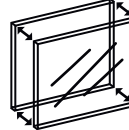
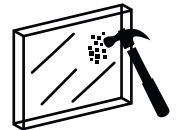
	Hermetic	System designed to create structures impenetrable by air, water or any element.
	Acoustics	System that significantly reduces external noise and allows for adequate hearing levels
	Low-E	System designed to control environmental effects, reducing the use of air conditioning equipment.
	What is a crystall monolytic?	It is a single sheet of glass that is manufactured by flotation process.
	What is a laminated glass?	They are two crystals held together by an intermediate layer.
	What is an insulated?	Combination of glass with an intermediate air space that creates an additional barrier to reduce air-to-air temperature transfer.
	What is a tempered glass?	Processed by thermal or chemical treatments, to increase its resistance, compared to normal glass.

DOORS & WINDOW SYSTEMS

Our trajectory has led us to design and perfect solutions, taking into account every last detail of each project. The Doors & Window Systems are made up of these 4 elements.

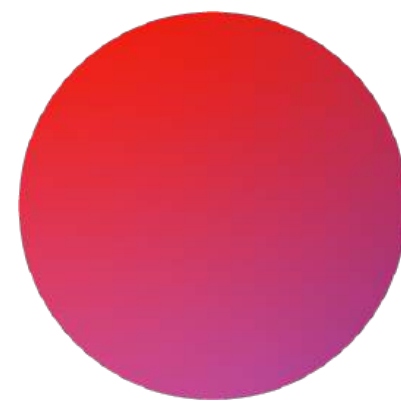

GLAZING

We take and include innovations in technology worldwide to provide solutions that guarantee the objective of each project.



WINDOWS

Our team seeks to follow and create trends, offering a unique and modern style, focused on solutions that are timeless while maintaining quality and functionality over time.

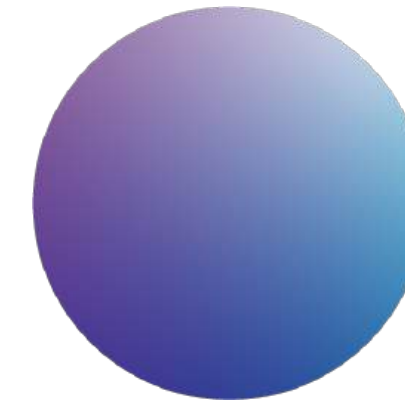

OPERATOR

We design projects to be able to offer our clients variety and options that increase the functionality and design of the solutions; leaving the common offer in the market, giving a product of exalted quality.

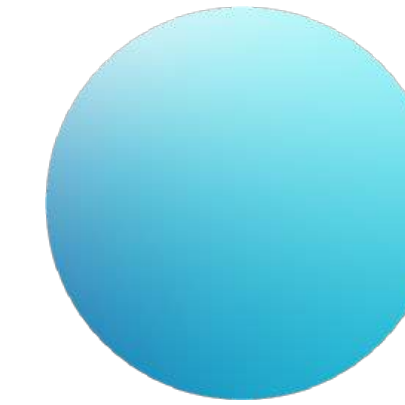

OPENING

We create Doors & Window Systems that guarantee the correct use of the opening solution of the project, meeting the specific needs of the client.

AVI150 SYSTEM

Reinforcing system designed to support and highlight great design facades, your ideal choice for large projects.

- Get the most out of this system with up to **40mm** of glazing.
- It is a system with very slender verticals, reinforcement profile of only **24 mm**.
- Its anchoring system is by means of structural angles.
- Allows integration with the **AVI-45** system, to generate modules on a facade. With the possibility of great heights.

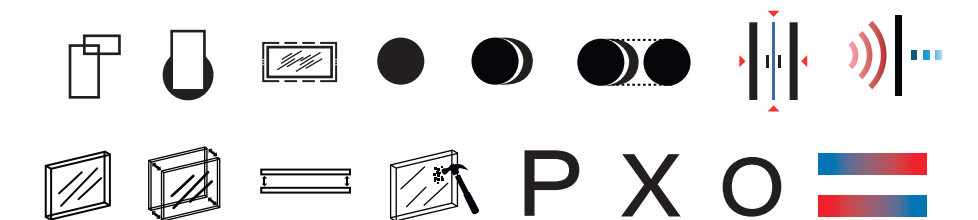

TYPE OF GLAZING ● ● ● ●

System designed to support and highlight any type of glass and configuration. Recommended for acoustic and hermetic projects.

● Get the most out of this system with up to **38 mm** of glazing.

SYSTEM TYPE

A profile designed to meet the aesthetic needs of any modern international development. Using high grammage aluminum, our **AVI150** system has a guarantee superior to the regular market, assuring design and quality for the project.

- Specialized system for high-rise projects and facades.
- Modern profiles and straight finishes.
- Electro-painted, anodized or sublimated finishes.
- High quality 45mm aluminum frames.



TECHNICAL DRAWING

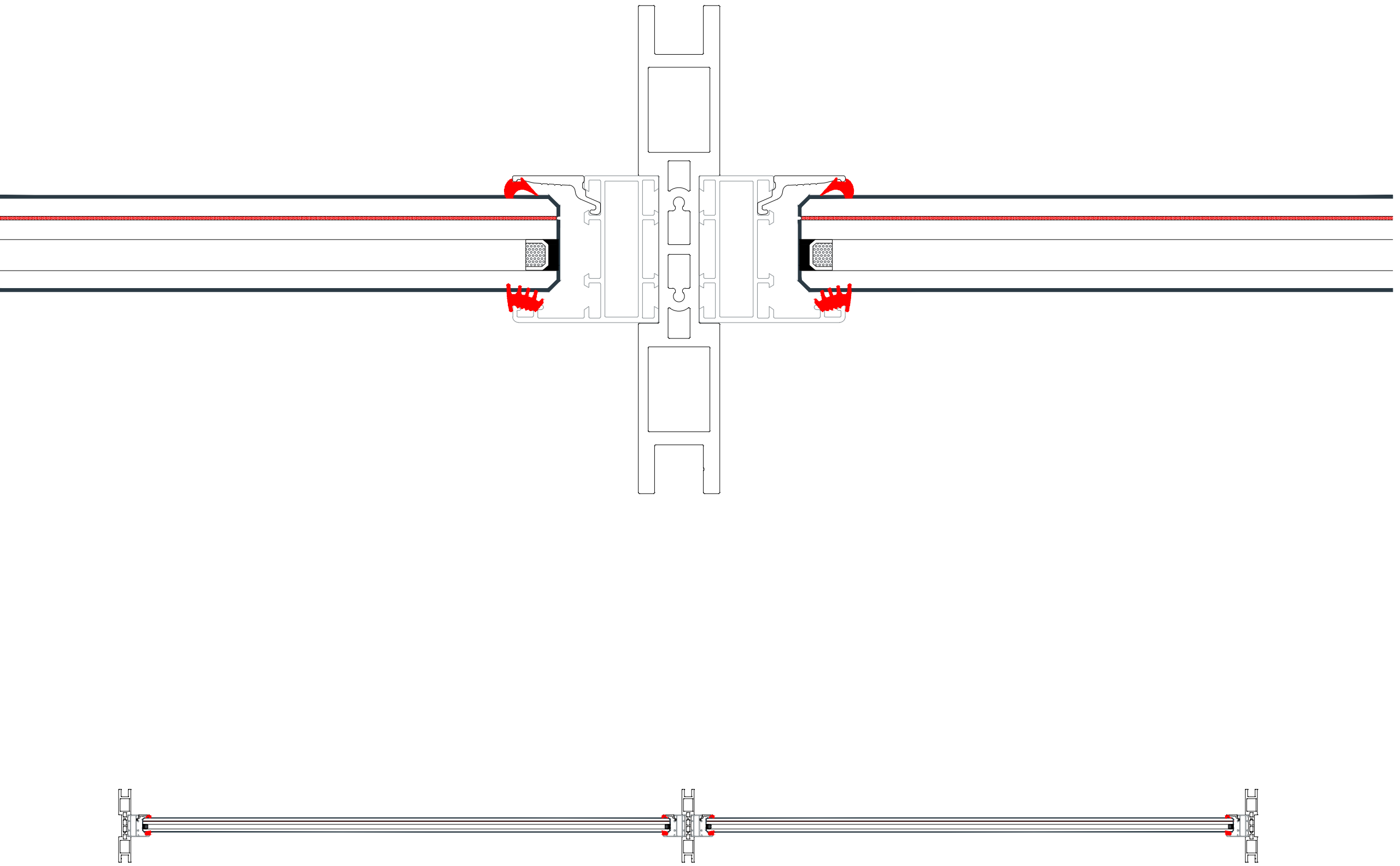
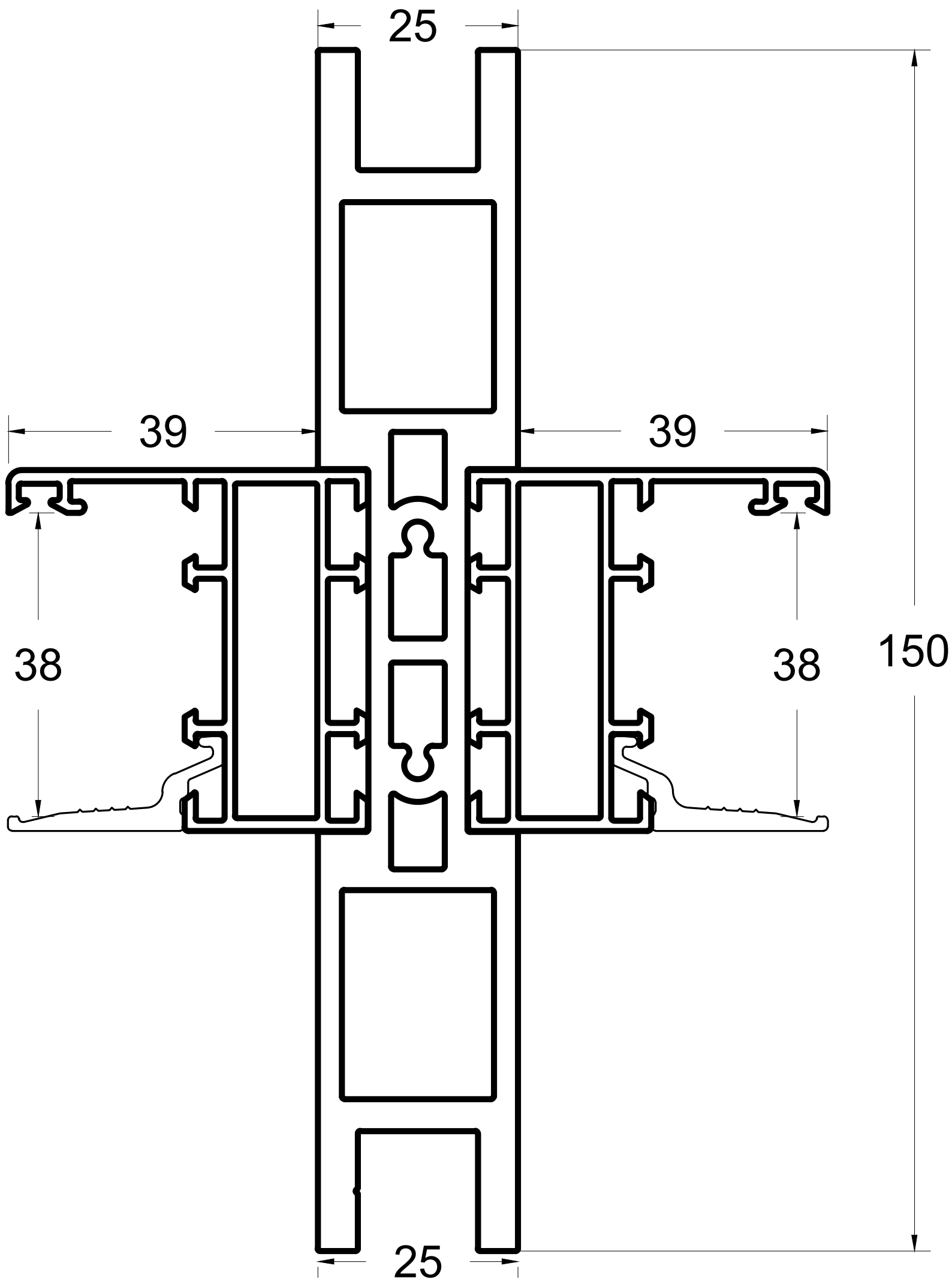







CLIENT REVIEWS

X The perfect match for the needs of our new home, without a doubt, a superior design guaranteed to last a lifetime.

JOSÉ CASAS Valle de Bravo.

X After several consultations with our AviPartner, we found the perfect product that eliminates 80% of the exterior noise and used it in the remodeling of our office.

GRISELDA MAGAÑA Interlux, CDMX

X The hotel looks spectacular after the change in the The Doors & Window Systems that we found in AviGlass.

JAVIER ROBLEDO Grupo Posadas, Los Cabos.

Doors & Window Systems
INTO THE FUTURE



NEW PROJECTS

52 5543849297

ejecutivocomercial@aviglass.com.mx

